

HYDROTEC

BODENHÜLSEN



GROUND SLEEVES

12/2018

BODENHÜLSEN - GUSS

ACCESSORIES GROUND SLEEVES - CAST IRON



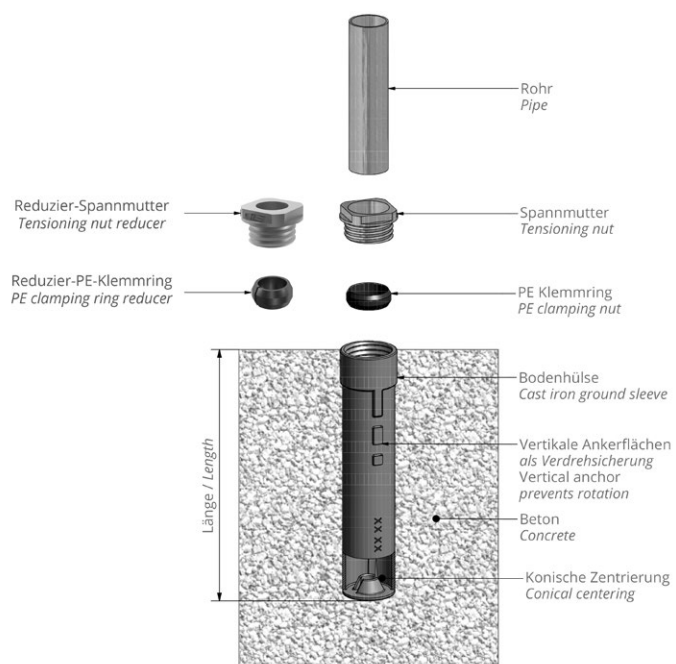

Maße / dimensions	Gewicht / weight	Art.-Nr. / Art.-no.
-------------------	------------------	---------------------

48 x 300 mm	4,2	561483 0000
60 x 300 mm	5,1	561603 0000
60 x 500 mm	7,2	561605 0000
76 x 300 mm	5,8	561763 0000
76 x 500 mm	8,8	561765 0000
76 x 800 mm	15,3	561768 0000
89 x 500 mm	10,0	561895 0000
114 x 500 mm	15,0	561114 5000



ZUBEHÖR BODENHÜLSEN - GUSS

ACCESSORIES GROUND SLEEVES - CAST IRON

Typ / Type	Art.-Nr. / Art.-no.	
Spannmutter, verzinkt / tensioning nut, galvanized		
48 mm	5511480000	 <p>Schraubverschlusskappe screw cap</p> <p>Reduzier-Spannmutter tensioning nut reducer</p>
60 mm	5511600000	
76 mm	5511760000	
89 mm	5511890000	
114 mm	5511114000	
Reduzier-Spannmutter, verzinkt / tensioning nut reducer, galvanized		
60 ≥ 48 mm	5515600000	 <p>Reduzier-PE-Klemmring PE clamping ring reducer</p> <p>Maulschlüssel wrench</p>
76 ≥ 60 mm	5515760000	
PE-Klemmring / PE-clamping ring		
48 mm	5512480000	
60 mm	5512600000	
76 mm	5512760000	
89 mm	5512890000	
114 mm	5512114000	
Reduzier-PE-Klemmring / PE clamping ring reducer		
60 ≥ 48 mm	5516600000	
76 ≥ 60 mm	5516760000	
Schraubverschlusskappe, verzinkt / screw cap, galvanized		
48 mm	5513480000	
60 mm	5513600000	
76 mm	5513760000	
89 mm	5513890000	
114 mm	5513114000	
Maulschlüssel / wrench		
60 mm	5514480000	
76 mm	5514890000	
114 mm	5514114000	

BODENHÜLSEN - STAHL

GROUND SLEEVES - STEEL

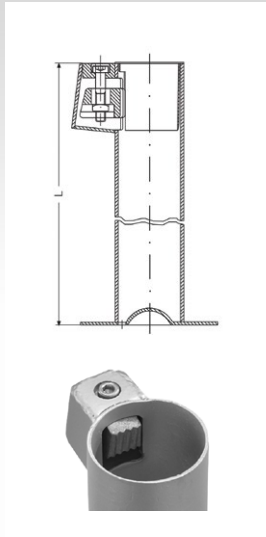

Maße / dimensions	Gewicht / weight	Art.-Nr. / Art.-no.
-------------------	------------------	---------------------

Für Rohrpfeiler rund / for bollards round

Ø 42 x 200 mm	1,3	562412 0000
Ø 42 x 300 mm	1,4	562423 0000
Ø 42 x 500 mm	1,8	562415 0000
Ø 48 x 300 mm	1,7	562483 0000
Ø 48 x 500 mm	2,6	562485 0000
Ø 60 x 300 mm	2,15	562603 0000
Ø 60 x 500 mm	3,0	562605 0000
Ø 76 x 300 mm	2,45	562763 0000
Ø 76 x 500 mm	3,2	562765 0000
Ø 90 x 500 mm	5,5	562905 0000

Maße / dimensions	Gewicht / weight	Art.-Nr. / Art.-no.
-------------------	------------------	---------------------

Stahl-Vierkanthülsen / steel - square ground sleeves





50 x 40 x 500 mm	1,4	562504 0500
60 x 40 x 500 mm	1,5	562604 0500
60 x 60 x 500 mm	3,0	562606 0500
80 x 50 x 500 mm	5,0	562080 5050
90 x 90 x 500 mm	5,8	562909 0500
100 x 100 x 500 mm	4,2	562101 1015
112 x 52,5 x 500 mm	5,0	562112 5250

Artikelbeschreibung / product description

- Feuerverzinkt mit Klemmkeil aus Guss / hot-dip galvanized and provided with a cast iron clamping wedge
- Klemmung erfolgt mittels Inbusschraube aus Edelstahl / clamping is carried out with a stainless steel Allen screw

ZUBEHÖR BODENHÜLSEN - STAHL

ACCESSORIES GROUND SLEEVES - STEEL

Typ / Type	Gewicht / Weight	Art.-Nr. / Art.-no.	
Verschlusskappe / cap			
Ø 42,3 mm	0,15	552420 0000	
Ø 48 mm	0,2	552480 0000	
Ø 76 mm	0,4	552760 0000	
Ø 60 mm	0,3	552600 0000	
Ø 90 mm	0,5	552900 0000	
Ø 114 mm	0,6	552114 0000	
Spezial-Bodenhülsen / special ground sleeves			
Vierkanthülse / 500x120x60 mit Doppelklemmung <i>square with Double clamping</i>	5,0	562120 6050	
Rundhülse Ø 60 x 170 mm mit Flanschring für mobile Verkehrsinseln <i>round sleeve Ø 60 x 170 mm with flangeas mobile traffic island</i>	2,6	561601 7000	
Rundhülse Ø 76 x 500 mm mit 3-fach Schraubklemmung <i>round sleeve Ø 76 x 500 mm with 3-side srew damping</i>	3,5	562765 0003	

Verschlusskappe / cap

Vierkanthülse mit Doppelklemmung
square with double clamping

Rundhülse mit Flanschring
round sleeve with flangeas

Rundhülse mit 3-fach Schraubklemmung
round Sleeve with 3-side screw damping

Bodenhülsen aus Stahl in rund, rechteckig oder quadratisch in unterschiedlichen Materialstärken und Längen wahlweise ausgestattet mit einem oder mehreren Klemmkeilen können nach Kundenwunsch gefertigt werden!

Ground sleeves of steel in round, rectangular or square in different thicknesses and lengths optionally equipped with one or more clamping wedges can be manufactured to customer!

FAHNENMASTHÜLSE

FLAGPOLE SLEEVE



Typ / Type	Art.-Nr. / Art.-no.
------------	---------------------

Fahnenmasthalter inkl. 4 Klemmkeile und Verschlussdeckel / *flagpole sleeve incl. 4 chocks and lid*

5627000000

Artikelbeschreibung / product description

Schnelles Einsetzen und Herausnehmen von Fahnenmasten. Einbau bündig mit dem Boden und somit für Verkehrsflächen einsetzbar. Der Mast wird mit 4 Keilen geklemmt. Der Deckel besteht aus zwei Winkelelementhälften. Je nach Steckposition der Winkelelementhälften kann die Hülse vollständig verschlossen werden (außerhalb der Beflaggungszeit) oder wenn der Mast steckt, der Rand rundherum abgedeckt werden.

Rapid insertion and removal of a flagpoles. Installation flush with the ground, so that it can be used for traffic areas. The mast is clamped with 4 wedges. The cover consists of two angle element halves. Depending on the slot position of the angular elements they close the sleeve completely (outside the flagging time) or cover the edges (when the mast is inserted).

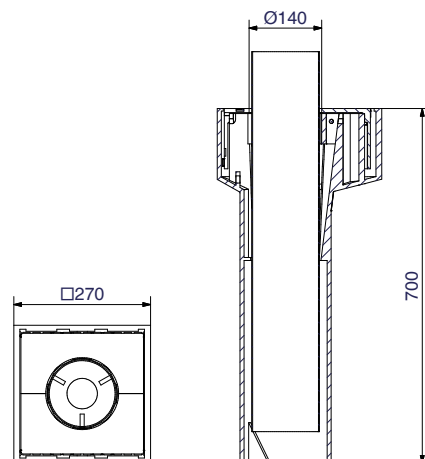

Gewicht / weight: ca. 45 kg
 Material / material: Grauguss / cast iron
 Einsetzbar für Mast-Durchmesser: 100 - 140 mm /
 usable for mast diameters: 100 - 140 mm

WEITERE BROSCHÜREN/KATALOGE

MORE BROCHURES/CATALOGS

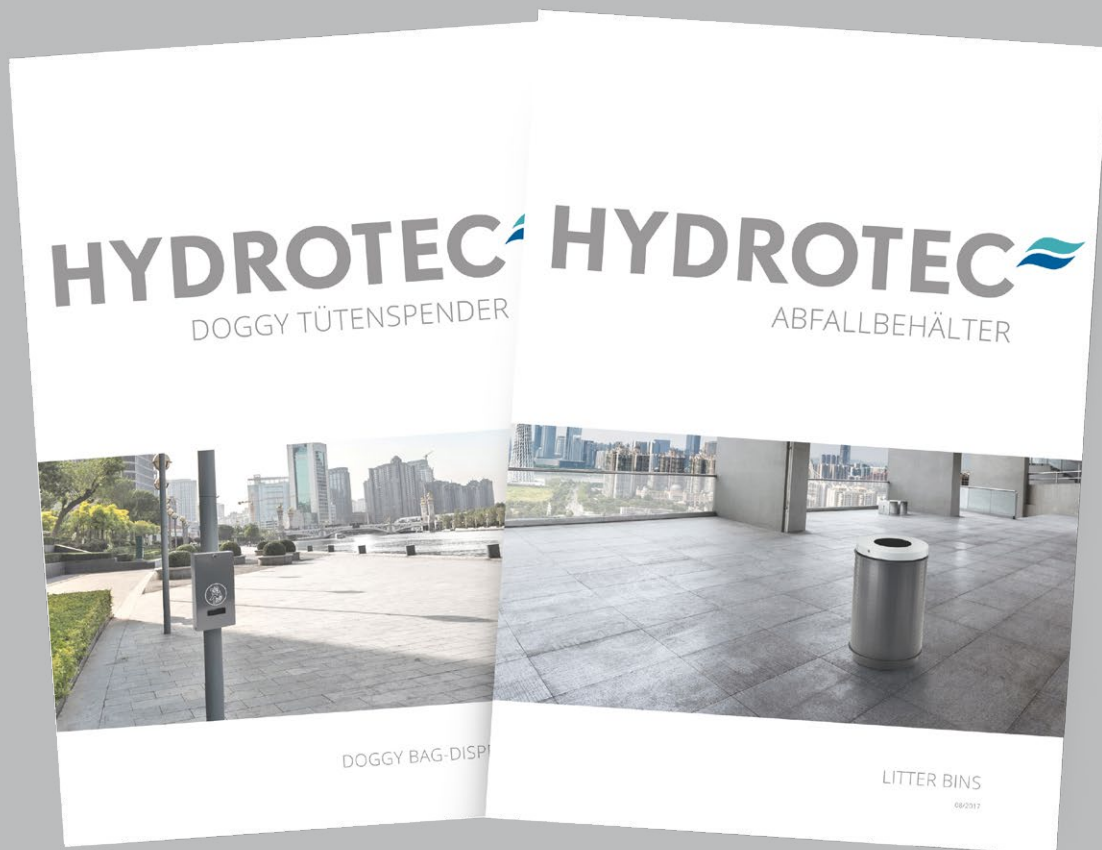



HYDROTEC Technologies AG
Düngstruper Straße 46
27793 Wildeshausen

 office@hydrotec.com

 +49 4431 9355-0

 www.hydrotec.com

 +49 4431 9355-88